

EAN: 6414150071218

www.oras.com/en/products/oras/product/2810F-104



- Green Building
- Single-lever, Green Building
- Deck mounted
- Chrome
- Standard aerator
- Single operating lever/handle, Hot/Cold symbols
- Limitation option for maximum temperature and flow-rate
- \varnothing 40 mm ceramic cartridge for flow and temperature control
- Flexible inlet pipes

Technical data

Flow properties

Flow-rate at 300 kPa (with flow controller) **0.056 l/s**

Technical properties

Hot water supply **max. +80°C**
 Working pressure **50 - 1000 kPa**

Regulations

EN standard **EN 817**
 Noise class **I (ISO 3822)**

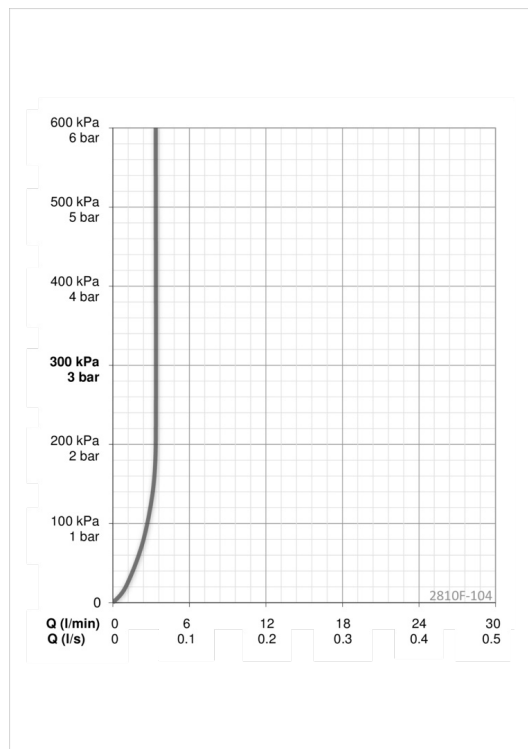

Spare parts

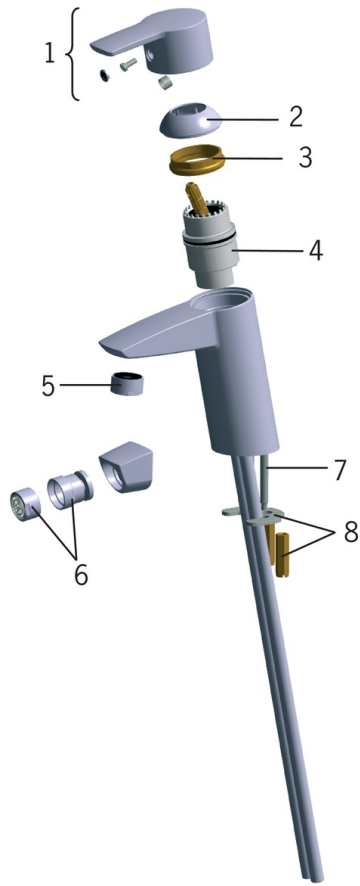

SP2810F-104

	Name	Code
01	Lever	159050V
02	Covering cap	159053V
03	Tightening nut	158726
04	Cartridge, Green building	600979V
05	Aerator, M24x1, -104	601434V
06	Aerator with ball joint, M24x1/M24x1	232511
07	Fixing screw (10 pcs), M6x55	158727/10
08	Fixing plates with nuts	158697