



# Oras

Installation and maintenance guide







4-6



## 2077

I (ISO 3822)  
100 - 1000 kPa  
0.38 l/s (300 kPa)  
max. +80°C

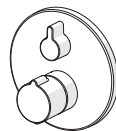
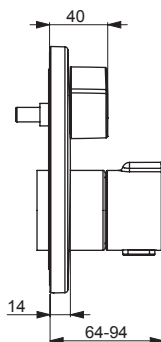
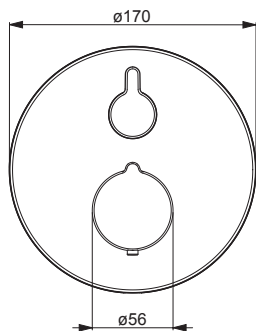

[mpi.oras.com/2077](http://mpi.oras.com/2077)

## 2078

I (ISO 3822)  
100 - 1000 kPa  
0.37 l/s (300 kPa)  
max. +80°C

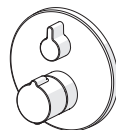
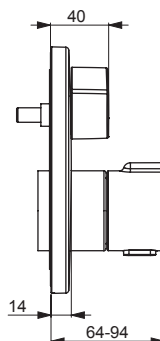
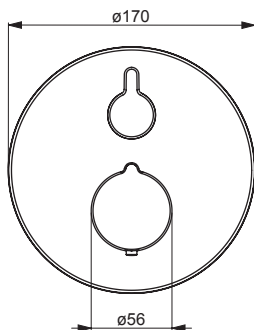

[mpi.oras.com/2078](http://mpi.oras.com/2078)

## 2087

I (ISO 3822)  
100 - 1000 kPa  
0.37 l/s (300 kPa)  
max. +80°C

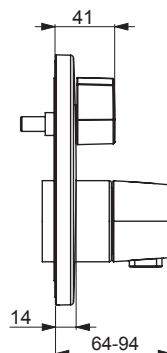
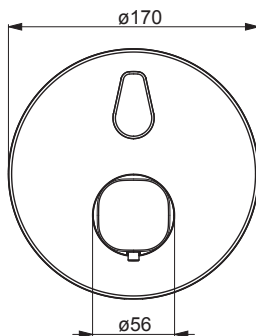

[mpi.oras.com/2087](http://mpi.oras.com/2087)

## 2088

I (ISO 3822)  
100 - 1000 kPa  
0.37 l/s (300 kPa)  
max. +80°C

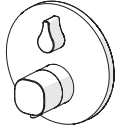
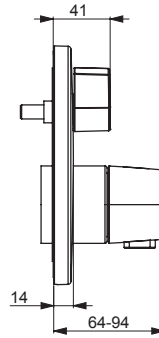
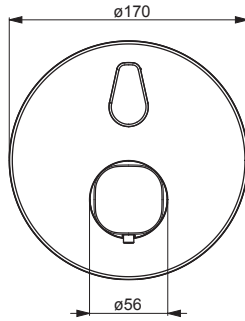

[mpi.oras.com/2088](http://mpi.oras.com/2088)

## 2097

I (ISO 3822)  
100 - 1000 kPa  
0.38 l/s (300 kPa)  
max. +80°C

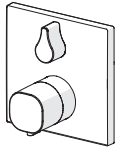
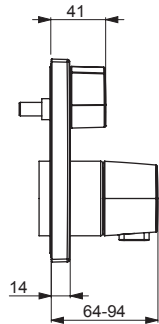
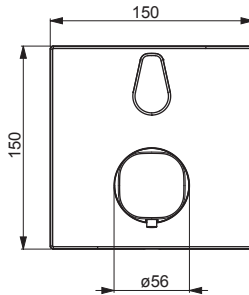

[mpi.oras.com/2097](http://mpi.oras.com/2097)

## 2098

I (ISO 3822)  
100 - 1000 kPa  
0.37 l/s (300 kPa)  
max. +80°C

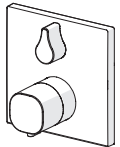
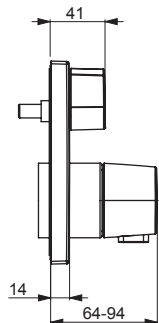
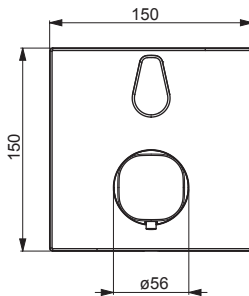

[mpi.oras.com/2098](http://mpi.oras.com/2098)



## 2067

I (ISO 3822)  
EN 1111  
50 - 1000 kPa  
0.35 l/s (300 kPa)  
100 kPa (0.2 l/s)  
max. +80°C

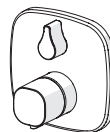
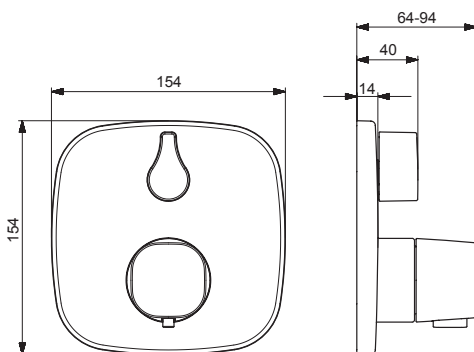

[mpi.oras.com/2067](http://mpi.oras.com/2067)

## 2068

I (ISO 3822)  
EN 1111  
50 - 1000 kPa  
0.35 l/s (300 kPa)  
100 kPa (0.2 l/s)  
220 kPa (0.3 l/s)  
max. +80°C

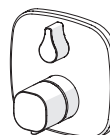
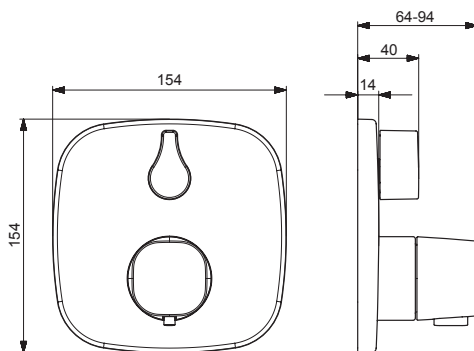

[mpi.oras.com/2068](http://mpi.oras.com/2068)

## 2064

50 - 1000 kPa  
max. +80°C

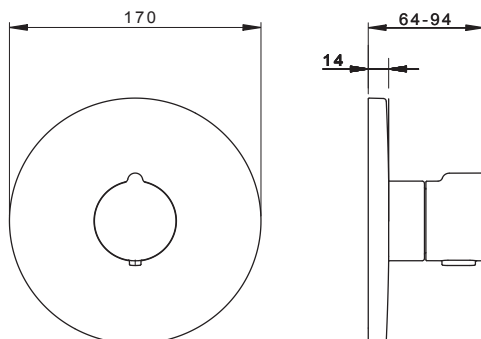

[mpi.oras.com/2064](http://mpi.oras.com/2064)



Oras Group is a powerful European provider of sanitary fittings: the market leader in the Nordics and a leading company in Continental Europe. The company's mission is to make the use of water easy and sustainable and its vision is to become the European leader of advanced sanitary fittings. Oras Group has two strong brands: Oras and Hansa.

The Group's head office is located in Rauma, Finland, and the Group has three manufacturing sites: Kralovice (Czech Republic), Olesno (Poland) and Rauma (Finland). Oras Group employs approximately 1,200 people in twenty countries. Oras Group is owned by Oras Invest, a family company and an industrial owner.

ORAS Ltd  
Isometsäntie 2, P.O. Box 40  
FI-26101 Rauma  
Tel. +358 2 83 161  
Fax +358 2 831 6300  
info.finland@oras.com  
www.oras.com



943247-01-21