

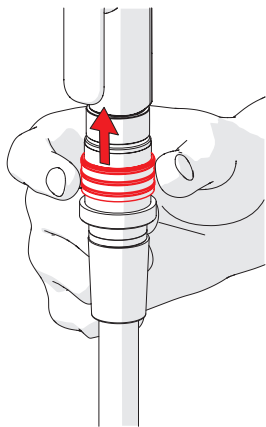

# Oras Medipro

Installation and maintenance guide

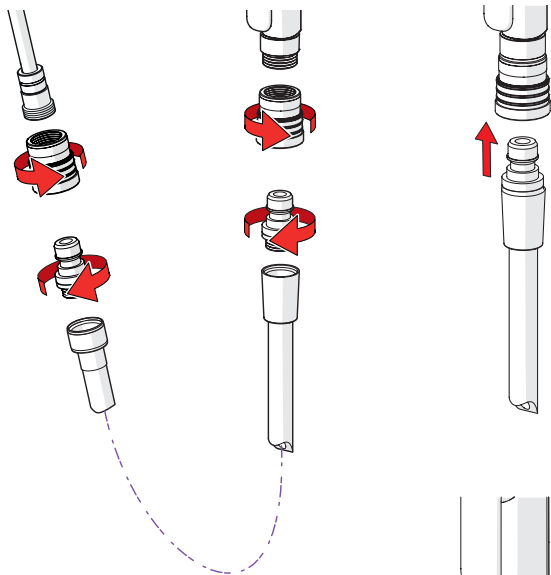





①

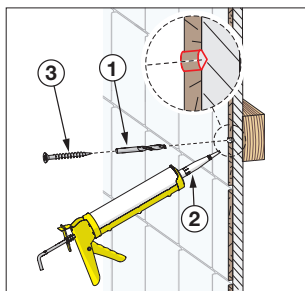
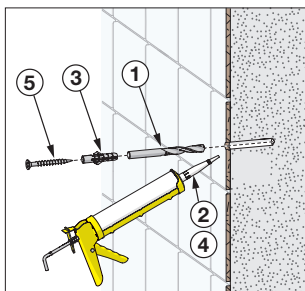
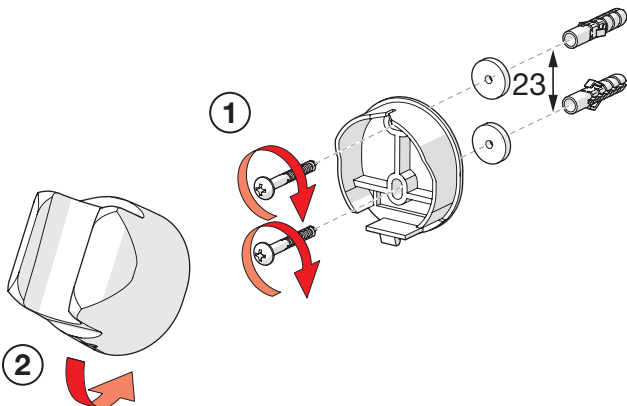

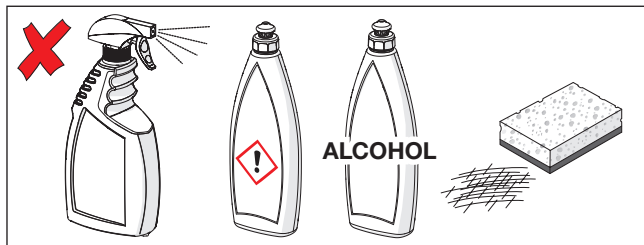
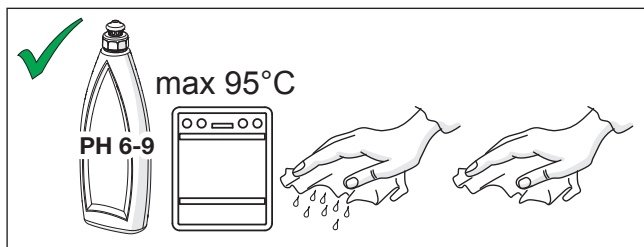
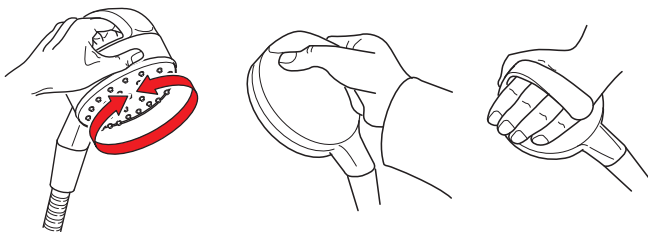

ORAS Ltd.  
Isometsäntie 2, P.O. Box 40  
FI-26101 Rauma  
Finland

Tel. +358 2 83 161  
Fax +358 2 831 6300  
info.finland@oras.com  
www.oras.com

943259-12-16